

Design of a sensor board for underground mines environment monitoring system

In this paper a development of miniature size low power integrated sensor board for the real-time environment underground mine monitoring system is presented. Advance sensor technology has introduced high sensitivity and small size, low power sensors. At the time of mining operations, it must be required to monitor noxious/explosive gases. The whole mine environment is affected due to release or produce of those gases. If, concentration level of noxious or explosive gases exceeds the safe limit, it suddenly creates an unsafe situation. To avoid this situation continuous real-time environment monitoring is mandatory today.

Keywords: Noxious gases, firedamp, miniature sensors, printed circuit board and underground mines.

I. Introduction

Mining has been accepted the world over as a hazardous profession and continuous struggle by the workforce with the unpredictable forces of nature [1]. Most of the accidents have occurred in underground mines are landslides, water breakage, gas explosion, fire explosion, roof collapses, and suffocations etc. These hazards pose a serious problem of managing safety and health risks to mine workers. Underground coal mines are beset with the presence of toxic gases such as carbon monoxide (CO), carbon dioxide (CO₂), and firedamp (methane-air mixture in coal mines) etc. In underground mines, especially in coal mines, various types of explosive and noxious gases are present. The whole mine environment is affected due to release or produce of those gases. If, concentration level of noxious or explosive gases exceed the safe limit, it suddenly creates an unsafe situation. Mine explosion is a serious and constant hazard caused by ignition of firedamp or coal dust in underground coal mines. The entire mine gallery is filled with dust and smoke, or water in case of inundation, hindering the visibility of rescue personnel. To avoid this situation continuous real-time environment monitoring is mandatory today. More attention is required and reliable, easy handling, low maintenance and long life device/system is needed for development.

Messrs. Yogendra Singh Dohare, Electrical Engg. Dept., Tanmoy Maity, Mining Machinery Engineering Dept. and P.S. Paul, Mining Engineering Department, ISM Dhanbad, India. E-mail: yogendradohare@yahoo.com; tanmoy_maity@yahoo.com; partha_sp99@yahoo.com

Safety inside underground mines requires attention of parameters such as temperature, humidity and various harmful mine gases that produced during mining operations. So, proper monitoring regarding safety should be maintained to avoid any kind of incident in underground mines. These include mainly measurement of levels of some noxious gases (i.e. CH₄, CO, and CO₂), humidity, temperature, etc. Work efficiencies of miners certainly are reduced due to increase in temperature and humidity. Methane is highly combustible and explosive in nature when it reaches about 5.4% to 14.8% in the air, but there is no explosion possible below an O₂ content of about 12%. Carbon monoxide (CO) is a particularly toxic gas. It burns in air with a blue flame and is explosive in presence of air at a concentration between 12.5% to 75% [2]. Carbon dioxide (CO₂) is not poisonous in the real sense but is asphyxiating. The threshold limit value of CO₂ is given as 5000 ppm. The oxygen content decreases considerably immediately after a mine-fire or explosion or due to the appearance of other gases in higher concentration. Directorate General of Mines Safety in India provides guidelines for precautions against inflammable and noxious gases in India. For the purpose of this regulation, inflammable gas shall be deemed to have been found or detected [3]. Threshold recommended level of different gases is shown in Table I.

TABLE I THRESHOLD LEVEL OF VARIOUS GASES

Mines gas	Threshold level	
	Per cent	ppm
1. Oxygen	19	190000
2. Carbon dioxide	0.5	5000
3. Carbon monoxide	0.005	50
4. Methane	a) 1.25 (in general body of the air)	12500
	b) 0.75 (in main return)	7500

II. Selection of mine sensors

Selection of low power, miniature size sensors is an important requirement for designing of real-time monitoring system. Mainly two types of sensors are used for gas detection or monitoring i.e. using non-dispersive infrared (NDIR) and electrochemical technologies. These are specifically designed to measure environment with much higher gas concentration [4]. Semiconductor based resistive, capacitive or impedimetric

devices are also cost-effective but good choice of gas sensors [5]. Based on the availability and suitability, following miniature size electrochemical sensors are selected for the proposed work: Methane sensor (TGS2611), carbon monoxide sensor (TGS2442), carbon dioxide sensor (TGS4161), oxygen sensor (KE-50), temperature and humidity sensor (RHI-110A). The pictorial view of all sensors is shown in Fig.1.

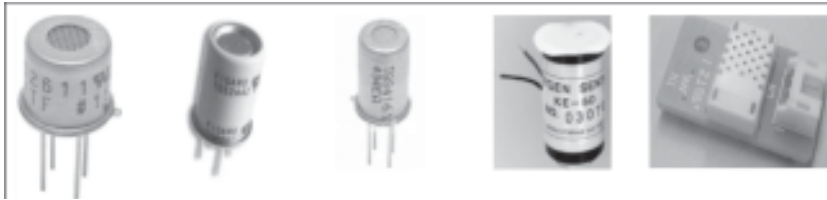

Fig.1 Pictorial view of selected sensors

Figaro make TGS2611 is a semiconductor type gas sensor for methane detection within the range of 500ppm-10000 ppm. The circuit diagram of the sensor is shown in Fig.2 [6]. In order to optimally sensing, heater voltage (V_H) applies to heating element R_H to maintain the sensing element R_S at specific temperature and circuit voltage V_C is applied for the purpose of measuring output voltage across the load resistance R_L .

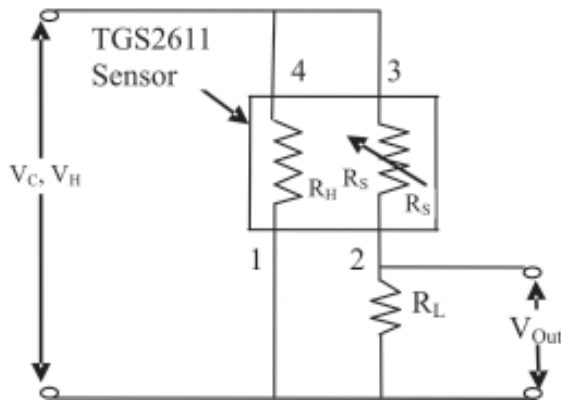

Fig.2 Circuit diagram of methane gas sensor (TGS2611)

From circuit diagram of TGS2611 sensor, the output voltage equation can be written as:

$$V_{RL} = \frac{(V_c)}{R_S + R_L} R_L \quad \dots \dots (1)$$

It can be finally written as:

$$V_{RL} = 1 + \frac{R_S}{R_O} \quad \dots \dots (2)$$

Empirical relation between the concentration level and the sensor resistance ratio is found at $\frac{R_S}{R_O} = \frac{D}{C^K}$, for $300 \text{ ppm} \leq C \leq 10000 \text{ ppm}$ $\dots \dots (3)$

where, $D = 46.2$ and $K = 0.45$ are constants.

Combining equation 2 and 3, it can be written as an

empirical relation between concentration level and output voltage:

$$V_{RL} = \frac{V_C}{(1 + 46.2C^{-0.45})}, \text{ for } 300 \text{ ppm} \leq C \leq 5000 \text{ ppm} \dots (4)$$

TGS2442 is semiconductor type with low power consumption sensor and it is used for carbon monoxide detection. Heater voltage (V_S) is applied to the heater element R_H only for 14 msec and therefore one second pulse (V_H) with 14msec t_{off} time is applied to T_1 . Again circuit voltage (V_S) is applied to the sensing element R_S for 5 msec and therefore one second pulse (V_C) with 5 msec t_{on} time is applied to T_2 is shown in Fig.3. Sensor resistance (R_S) is calculated with a measured value of V_{OUT} as follows [7] as:

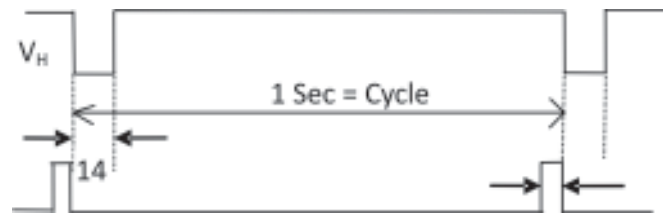

Fig.3 Heater and circuit voltage pulse

$$R_s = \left(\frac{V_S L_L}{V_{out}} - R_L \right) \quad \dots \dots (5)$$

or

$$\text{It can be written as: } V_{OUT} = \frac{V_S R_L}{R_S + R_L} \quad \dots \dots (6)$$

TGS4161 is a solid electrolyte type sensor. Heater voltage (V_H) is applied to heating element R_H in order to maintain the sensing element temperature. The CO_2 gas concentration levels are measured by the changes in EMF at the output terminal. These values are calculated by the Nernst's equation [8].

$$\text{EMF (mV)} = ((E_C - (R^*T) / 2F) \ln (P (\text{CO}_2))) \quad \dots \dots (7)$$

where,

$P (\text{CO}_2)$ is the concentration of CO_2 in ppm;

E_C is the half cell reduction potential or constant value;

R is gas constant (8.314 L/(mol). K);

T is the temperature in (Kelvin) and F is Faraday constant.

III. Testing and calibration of sensors

Individual testing and calibration of sensors are performed in the laboratory in order to understand the sensor characteristics and sensitivity toward the target gases. All gases used in the calibration are certified to a tolerance of <5% deviation from the stated concentration. For the calibration purpose, recommended gas cylinders with regulated concentration are used. In this paper only a

calibration and testing of methane gas sensor is presented.

The first step in the calibration process of TGS2611 gas sensor is to determine the value of load resistance for the sufficient resolution around the set alarm point. In the internal circuit diagram of TGS2611 in Fig.2, the load resistance and sensor resistance are in series and form a standard voltage divider. Testing and calibration set up is arranged in the laboratory as shown in Fig.4. Fixed value (3.3KΩ) of resistance is used as a load for the purpose of determining requisite load resistance value for the gas threshold level of 2.5V. Output voltages across the load resistance are observed with the changes of gas concentration level are listed in Table II.



Fig.4 Laboratory set up for TGS2611 methane sensor

TABLE II CONCENTRATION LEVELS OF METHANE GAS

	Gas concentration ion ppm	Output voltage in volts
1.	900	1.628
2.	1120	1.692
3.	1505	1.850
4.	2500	2.123
5.	3850	2.377
6.	5000	2.495

IV. Mine gas sensor board

Intrinsic safety (IS) is a low-energy signaling technique that prevents explosions from occurring by ensuring that the energy transferred to a hazardous area is well below the energy required to initiate an explosion [9]. In underground mines, hazardous areas are formed due to the presence of inflammable or explosive gases. For this reason, electrical equipment, used in underground mines, whether it is lighting, an environmental monitoring system or a telephone, needs to be specially designed with intrinsic safe circuit so that it will not cause an explosion. For the design of sensor board here, the circuit is incorporated with additional components for providing the required safety. The additional circuit incorporated in the design is shown in Fig.5. Z₁ and Z₂ Zener diodes are used to regulate the voltage level and a resistor is used to regulate the current. This finally limits the energy within an acceptable range. Moreover, the maximum voltage level used for the circuit is +5 V DC which is well below the maximum recommended value of 25 V.

After the selection and testing of sensors, all sensors are integrated in a compact small size single board called as sensor board. The circuit is designed with integration of sensors using PSIM software. The complete circuit diagram is shown in Fig.6. All components of this circuit are powered

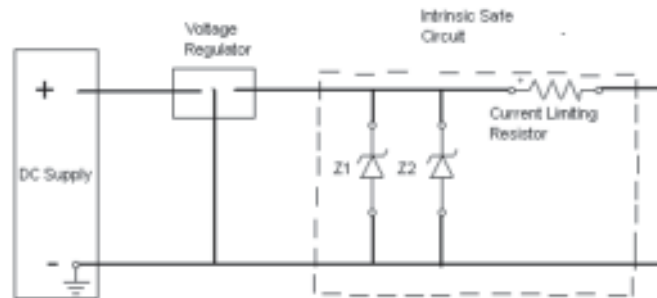

Fig.5 Intrinsic safe circuit for the sensor board

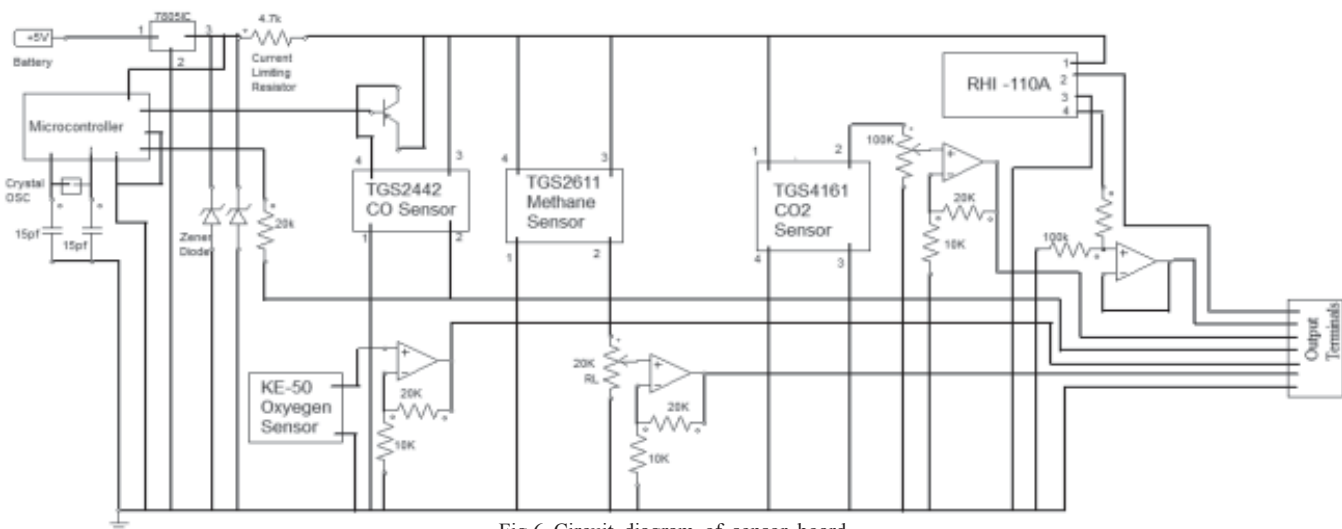

Fig.6 Circuit diagram of sensor board

by +5v battery only and single power supply operational amplifiers are used to amplify output voltage.

PCB layout is designed using PCB wizard design software is shown in Fig.7 and picture of the fabricated complete PCB is shown in Fig.8.

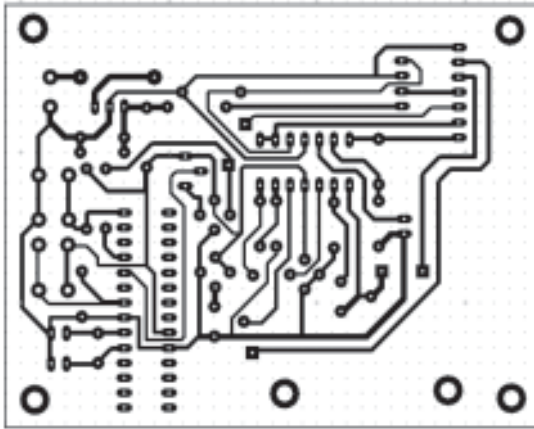

Fig.7 Artwork of PCB

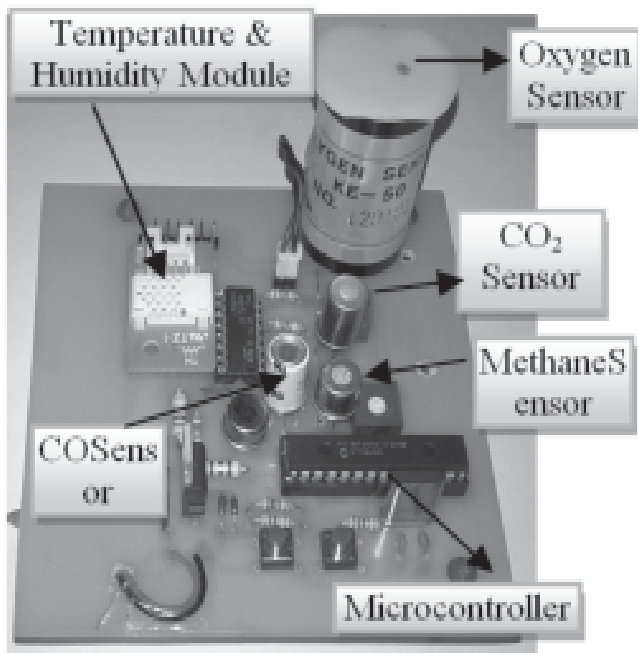

Fig.8 Complete sensor board

V. Conclusions

In the interests of mine safety and productivity, it is vital that operators are continuously aware of underground conditions and risk profiles. They must be able to locate and communicate with mine workers at all times - particularly in the event of fires, roof falls or other life-threatening situations. The individual sensors are calibrated and tested in a laboratory. After that with required intrinsic safety, miniature size gas sensor board is designed for the monitoring of noxious/explosive gases as well as temperature and humidity in the underground mine environment.

Reference

- [1] Biswas, A. (2001): Analysis of Accidents in India, *Journal of Mines, Metals and Fuels*, vol. 49, pp.50-57.
- [2] Misra, G. B. (1986): Mine Environment and Ventilation, Oxford University Press, pp.619.
- [3] <http://dgms.gov.in/legislation.php>. Retrieved at 24th June 2015.
- [4] L. V. Shum, P. Rajalakshmi, A. Afonja, G. McPhillips, R. Binions, L. Cheng, S. Hailes, (2011): "On the Development of a Sensor Module for real-time Pollution Monitoring," IEEE International Conference on Information Science and Applications (ICISA), pp.1-9.
- [5] García Mandayo, G., Herrán, J., Castro-Hurtado, I. and Castaño, E. (2011): Performance of a CO₂ Impedimetric Sensor Prototype for Air Quality Monitoring, *Sensors*, pp.5047-5057.
- [6] TGS 2611 - for the detection of Methane. https://www.google.co.in/?gfe_rd=cr&ei=x9qUVanJN-fl8AfxtrzICw#q=tgs2611. Retrieved at 18th April 2013.
- [7] TGS 2442 - for the detection of Carbon Monoxide (Datasheet). <http://www.meditronik.com.pl/doc/b0-b9999/tgs2442.pdf>. Retrieved at 30th June 2013.
- [8] Technical information for TGS4161. <http://www.netzmafia.de/skripten/hardware/Datenblaetter/Gassensoren/TGS4161Dtl.pdf>. Retrieved at 20th June 2014.
- [9] AN9003 - A Users Guide to Intrinsic Safety. http://www.mtlint.com/images/uploads/datasheets/App_Notes/AN9003.pdf. Retrieved on 10th March 2014.